

**Features**

- 0.5 INCH CHARACTER HEIGHT.
- LOW CURRENT OPERATION.
- HIGH CONTRAST AND LIGHT OUTPUT.
- EASY MOUNTING ON P.C. BOARDS OR SOCKETS.
- MECHANICALLY RUGGED.
- STANDARD: GRAY FACE, WHITE SEGMENT.
- RoHS COMPLIANT.

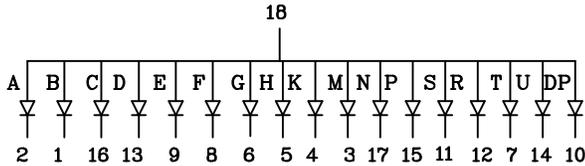

Notes:

1. All dimensions are in millimeters (inches).
2. Tolerance is  $\pm 0.25(0.01")$  unless otherwise noted.
3. Specifications are subject to change without notice.

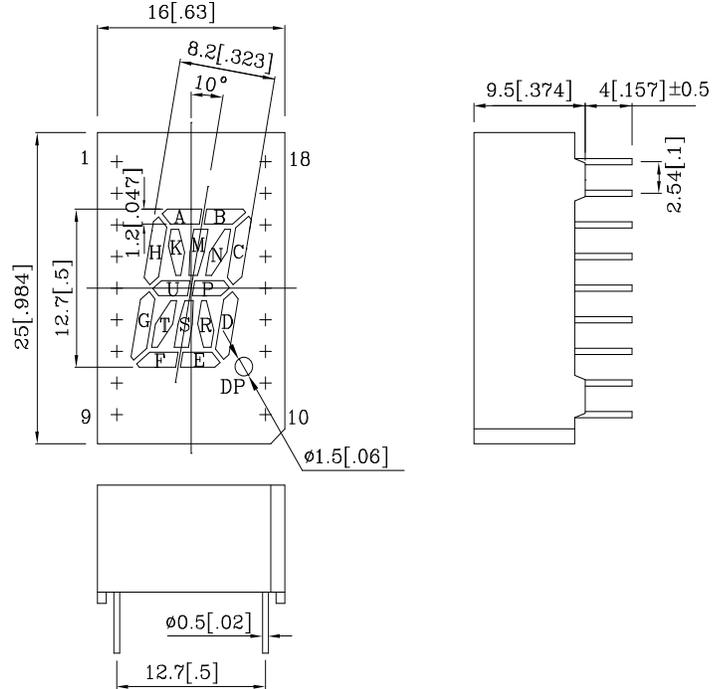

Absolute Maximum Ratings (TA=25°C)		MR (GaAlAs)	Unit
Reverse Voltage	VR	5	V
Forward Current	IF	30	mA
Forward Current (Peak) 1/10 Duty Cycle 0.1ms Pulse Width	iFS	155	mA
Power Dissipation	PT	75	mW
Operating Temperature	TA	-40 ~ +85	°C
Storage Temperature	Tstg	-40 ~ +85	
Lead Solder Temperature [2mm Below Package Base]	260°C For 3-5Seconds		

Operating Characteristics (TA=25°C)		MR (GaAlAs)	Unit
Forward Voltage (Typ.) (IF=10mA)	VF	1.8	V
Forward Voltage (Max.) (IF=10mA)	VF	2.5	V
Reverse Current (Max.) (VR=5V)	IR	10	uA
Wavelength of Peak Emission (Typ.) (IF=10mA)	$\lambda p$	660	nm
Wavelength of Dominant Emission (Typ.) (IF=10mA)	$\lambda D$	640	nm
Spectral Line Full Width At Half-Maximum (Typ.) (IF=10mA)	$\Delta\lambda$	20	nm
Capacitance (Typ.) (VF=0V, f=1MHz)	C	45	pF

Part Number	Emitting Color	Emitting Material	Luminous Intensity (IF=10mA) ucd	Wavelength nm $\lambda P$	Description
			min.	typ.	
AMR13A-A	Red	GaAlAs	4700	17990	660 Common Anode, Rt. Hand Decimal
Published Date : MAR 13,2008      Drawing No : SDSA2328      V4      Checked : Shin Chi      P.1/4					

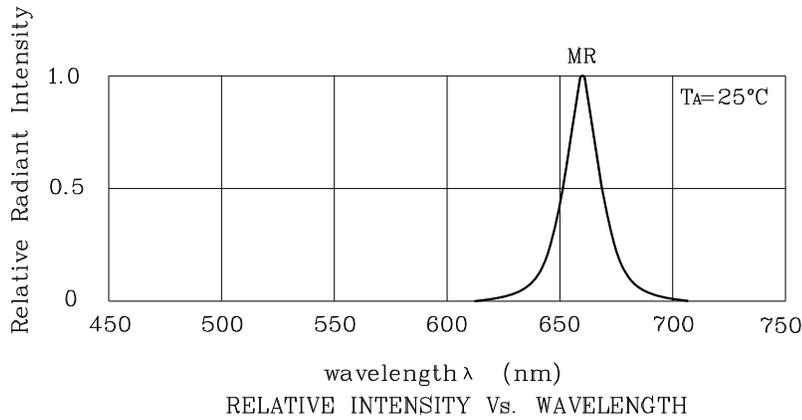

❖ MR

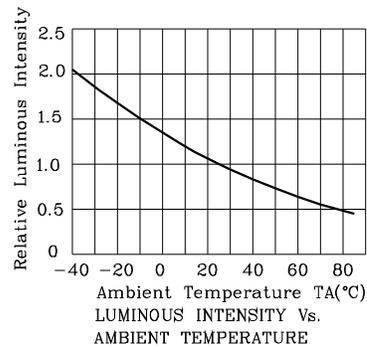
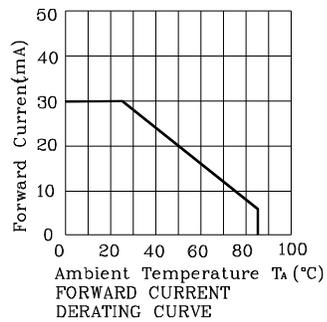
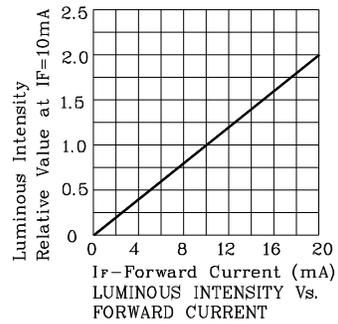
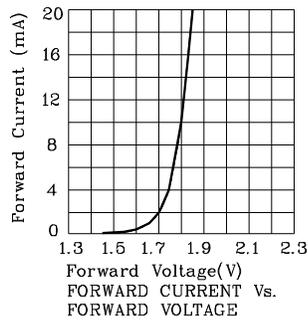

Wave Soldering Profile For Lead-free Through-hole LED.

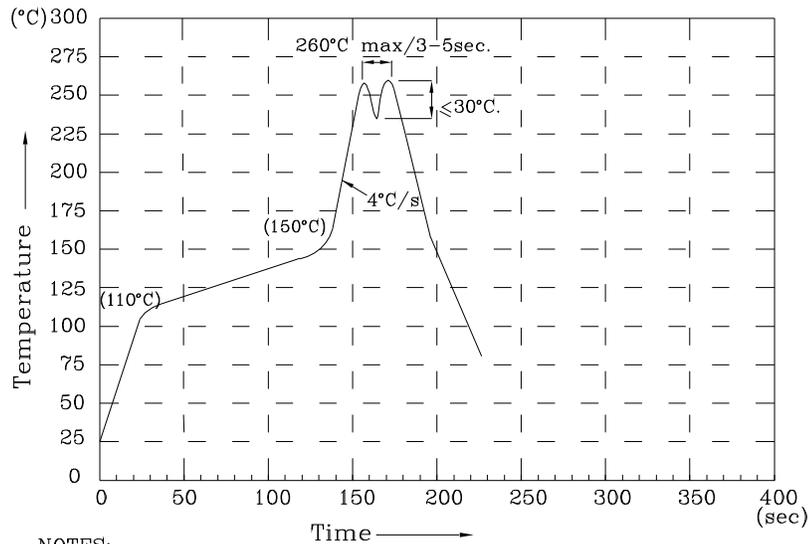

NOTES:

1. Recommend the wave temperature 245°C~260°C. The maximum soldering temperature should be less than 260°C.
2. Do not apply stress on epoxy resins when temperature is over 85 degree°C.
3. The soldering profile apply to the lead free soldering (Sn/Cu/Ag alloy).
4. No more than once.

Remarks:

If special sorting is required (e.g. binning based on forward voltage, Luminous intensity / luminous flux, or wavelength), the typical accuracy of the sorting process is as follows:

1. Wavelength: +/-1nm
2. Luminous intensity / luminous flux: +/-15%
3. Forward Voltage: +/-0.1V

Note: Accuracy may depend on the sorting parameters.

**PACKING & LABEL SPECIFICATIONS**

**AMR13A-A**

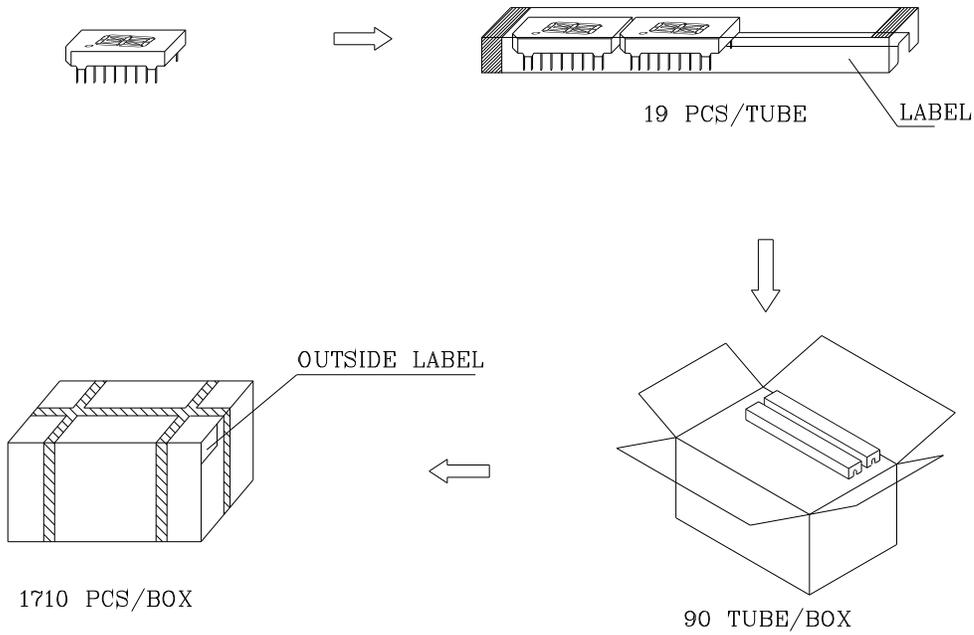

Inside LABEL Paste On The IC-tube

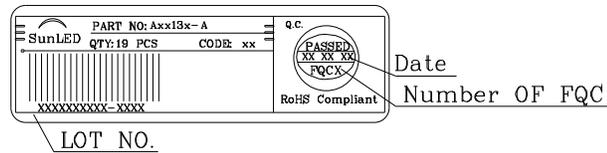

Outside LABEL Paste On The Box

